



Subwoofer system



GL-118-B

User manual



This manual has been designed to help GL 118 B system users from Pro DG Systems to its correctly use and understand its benefits and versatility.

Before using the product, carefully read “Precautions” section of this manual (pages 3 - 4). Please keep this document in a safe place for future reference.

The information included in this document may be changed without prior notice. To stay up to date with the latest version of this document, we recommend that you periodically consult Pro DG Systems website.

When reselling this product, give this document to the new owner. If you supply Pro DG Systems products, please inform your customers about this document.

Index

Precautions	3 - 4
Warranty	4
Declaration of conformity	6
Introduction	
- Description	6
- Technical datasheet	7
- Architectural specifications	8
User guide	
- First steps	8
- Troubleshooting	9 - 10
Speaker	11
Placement for best performance	
- Description	12
- In-block	12 - 13
- L & R Stack	13
- Reversed Stack	14
- End-Fired	15 - 16
- In-line cardioid	17 - 18
- In-line horizontal	19 - 20
- In-arc (virtual and physical)	21
Accessories	22

Precautions

Please read, keep and follow all safety and use instructions.

Important Safety Instructions.

1. Heed all warnings.
2. Do not overload the box to avoid damage to the speakers.
3. Do not use this product near water. If the box is used outdoors, make sure that no humidity can enter the box.
4. Clean only with a dry cloth.
5. Do not block any ventilation openings. Install in accordance with the manufacturer's instructions.
6. Do not install near any heat sources such as radiators, heat registers, stoves or similar (including amplifiers).
7. Do not defeat the safety purpose of the polarized or grounding-type plug. A polarized plug has two blades with one wider than the other. A grounding-type plug has two blades and a third grounding prong. The wider blade or third prong is provided for your safety. If the provided plug does not fit in your outlet, consult an electrician for replacement of the obsolete outlet.
8. Protect the power cord from being walked on or pinched, particularly at plugs, convenience receptacles, and the point where it exits from this product.
9. Only use attachments/accessories specified by the manufacturer.
-  10. Use only with the cart, stand, tripod, bracket or table specified by the manufacturer or sold with the product. When a cart is used, use caution when moving the cart/product combination to avoid injury from tip-over.
11. Unplug this product during lightning storms or when unused for long periods of time.
12. Refer all servicing to qualified personnel. Servicing is required when the product has been damaged in any way such as power-supply cord or plug is damaged, liquid has been spilled or objects have fallen into the product, the product has been exposed to rain or moisture, does not operate normally, or has been dropped.

WARNINGS / CAUTIONS:



This symbol on the product means there is uninsulated, dangerous voltage within the product enclosure that may present a risk of electrical shock.



This symbol on the product means there are important operating and maintenance instructions in this guide.



This symbol indicates that the product cannot be treated as ordinary household waste, it must be deposited at the corresponding collection point for electrical and electronic equipment.



This product contains magnetic material. Consult your doctor on whether this might affect your implantable medical device.



Contains small parts which may be a choking hazard. Not suitable for children under age 3.

Warranty

All the Pro DG Systems products have a 24-month warranty period, which begins from the invoice date of the first purchase.

Consult everything relevant to the warranty conditions at Pro DG Systems website: <https://prodgsystems.com/20-vc-warranty.html>

Or via email at: info@prodgsystems.com

Declaration of conformity



Pro DG Systems declares that the product with reference **GL 118 B** complies with the objectives expressed in the following **European Directives**:

- Low voltage 2014/35/UE.
- Electromagnetic compatibility 2014/30/UE.
- RoHS 2011/65/UE. About restrictions on the use of certain dangerous substances in electrical and electronic equipment.
- RAEE / WEEE 2012/19/UE. About waste electrical and electronic equipment.
- General Product Safety 2023/988/UE.



And it complies with the following **European Harmonized Standards**:

- EN 60065:2014. Audio, video and analog electronic devices.
- EN 55032:2012. Electromagnetic compatibility of multimedia equipment. Part 1: emission requirements.
- EN 55103-2:2009. Electromagnetic compatibility. Part 2 Immunity.

This declaration is available for request by email: info@prodgsystems.com

Or to be downloaded from the website: www.prodgsystems.com

Description

GL 118 B is one of the subwoofer systems of the new **GL Series**.

The new GL Series from **Pro DG Systems** has been developed with the purpose of offering the best quality-price ratio on the market. Specifically designed to work as LF reinforcement of our line array model GL 210.

Designed in Spain, the new GL 118 B is the 18" passive subwoofer system with the best quality-price ratio on the market.



Equipped with one 18" speaker with ferrite magnet in a tuned enclosure.

The construction of GL 118 B system is made of birch plywood using CNC machining, with water-based paint. Its front part is protected by a robust metal grille and acoustic foam.

Easy to transport thanks to its compact size, it incorporates side handles for easy handling.

The perfect solution as main PA at outdoor events or permanent installation. Ideal for working in live concerts, theaters, coverage under amphitheaters, places of worship, corporate applications and all types of events where high performance and versatility are necessary.

Technical datasheet

GL 118 B

Power handling	800 W RMS / 1600 W program / 3200 W peak.
Maximum SPL Calculation	1m / 122 dB continuous / 125 dB program / 128 dB peak.
Nominal impedance	8 Ohm.
Frequency range	35 - 180 Hz.
Dispersion angle	Omnidirectional.
Components	One 18" speaker. Ferrite. 800 W RMS.
Recommended Frequency cut-off *	Up to 100 Hz. Linkwitz-riley 24 filter.
Connectors	2 x Speakon NL4 MP.
Construction	Birch plywood using CNC machining. 2mm thick perforated steel front grille, with oven-dried black electrostatic powder paint finish. Includes acoustic foam.
Paint	Water-based paint. Black color (standard).
Dimensions (height x width x depth)	565 x 700 x 548,5mm (22,24 x 27,56 x 21,59in).
Weight	51,9 Kg (114,42 lbs) net / 54 Kg (119,05 lbs) with packaging.

* Disrespect the suggested frequency cuts-off on the different ways may cause components breakage.

Architectural specifications

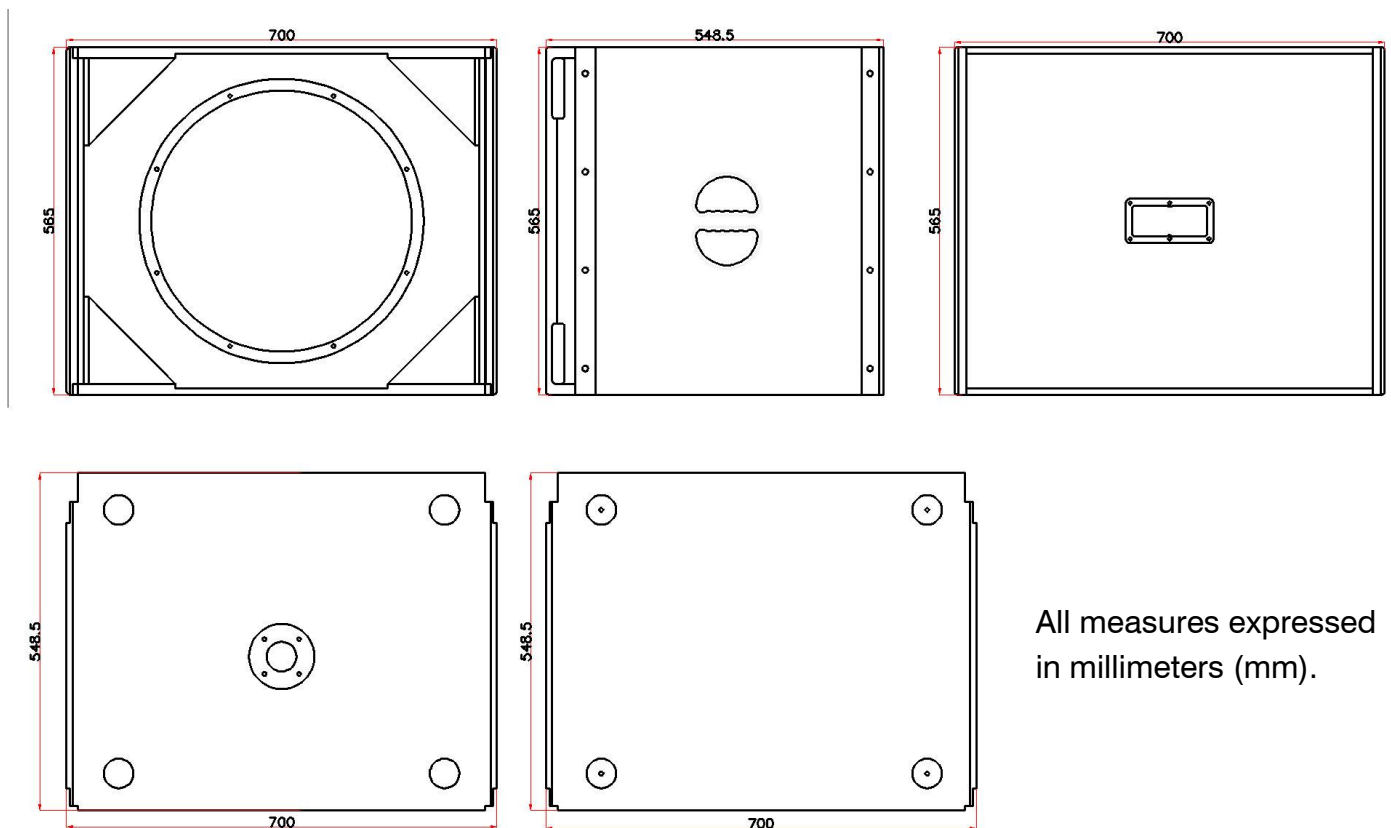

All measures expressed in millimeters (mm).

User guide. First steps

Turning On / Off

Turning on any sound system must be done from back to front. Turn on sources such as CD players first, then the mixer, then the processors, and finally the amplifiers.

When turning off the sound system, follow the reverse process, turning off the amplifiers before any other element of the system.

Both the power connector and the cabling must always be accessible and must never be covered or blocked.

To disconnect the power, remove the Speakon NL4MP type cable from the connector located on the rear plate of the equipment, perform this operation on all boxes.

Important: do not unplug the computer when music is playing.

User guide. Troubleshooting

Problem	Cause	Solution
Neither unit sounds.	<ol style="list-style-type: none">1. The amplifier is not sending signal.2. Defective cable.3. Excessive number of speakers connected to the same amplifier channel.	<ol style="list-style-type: none">1. Check that the amplifier is turned on and that the gain is not at minimum.<ol style="list-style-type: none">a. Check that the signal is reaching the amplifier from the mixing console.2. Make sure the cables are connected correctly and none are damaged. If so; use another cable.3. Check the minimum impedance that your amplifier can handle.
No sound on one unit.	The unit is not receiving signal.	Check that the signal cable is connected correctly; if damaged, replace it.
Distorted sound signal.	The mixer or other signal is distorting.	Lower the overall mixer output level or channel gain. Check that the signal source is ok.
Distorted and very loud sound signal.	The system is being overloaded with too much input signal and has reached maximum power.	Lower the mixer output level.

<p>Noise or buzz when light controls are used in the same environment.</p>	<ol style="list-style-type: none"> 1. The sound system is connected to the same phase than the lights. 2. The sound cables are too close to the light cables. 	<ol style="list-style-type: none"> 1. Connect the sound system and lighting system to different phases. Request the help of an electrician. 2. Aleje los cables de audio de los cables de luces.
<p>The system does not turn on even though the power cable is correctly connected, both to the network and to the box.</p>	<ol style="list-style-type: none"> 1. Defective cable. 2. Internal fuse blown. 	<ol style="list-style-type: none"> 1. Check the cables, connectors and power outlet with a tester or multimeter. 3. Contact your Pro DG Systems distributor or authorized professional to perform the repair.



If you have any technical problem or questions about Pro DG Systems products; contact our technical support department at: sat@prodgsystems.com

Speaker

GL 118 B includes one 18" speaker with ferrite magnet.



Main characteristics
Power handling of 800 W RMS / 1600 W program
Optimized cooling system
4" edgewound CCA voice coil
Aluminum demodulating ring
Triple roll surround

Placement for best performance

Generally, the construction of a subwoofer system generates omnidirectional sound dispersion, incorrect placement of subwoofer systems can generate undesirable effects on sound dispersion, such as cancellations (passages), excessive summation in the rear, poor coverage in the public area, etc.

The correct placement of the subwoofer systems depends on the characteristics of the place to be provided with sound, which is a key point to guarantee the success of the event. You will find some examples down below.

In summary:

- **In-Block** and **L & R stack** configurations; create a lot in the control area and also create the famous “passages” or cancellations in the public area.
- **Reversed stack** and **In-line cardioid** configurations; create a significant decrease in level on the stage and a slight decrease in pressure in the audience area.
- With **In-line horizontal configuration**; we will obtain a narrow and long coverage, with a sufficient level on the stage and a homogeneous response in the audience area.
- **End-Fired** configuration; produces homogeneous coverage and a fairly significant level reduction on the stage.
- With **In-arch configuration**; the response remains homogeneous, expanding the coverage and reducing the rear level.

In-Block subwoofers configuration

Using two in-line subwoofers.

Two sources fed with the same signal, time, level and polarity.

This configuration generates omnidirectional sound dispersion throughout virtually the entire operating frequency range.

The pressure level is +1.5 dB compared to the configuration of two subwoofers stacked on top of each other.



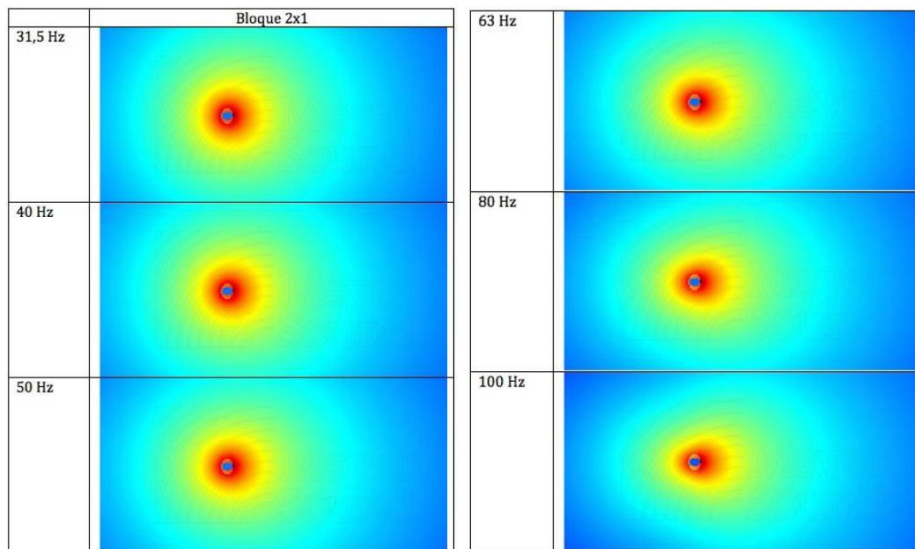

L & R stack subwoofers configuration

Using 3 subwoofers in stack format

The results are very similar to those obtained with the block configuration are obtained.

We gain some dB, but still had no control at the rear.

Not having control over the rear generates more dB in the audience area, but it will bother your stage colleagues.

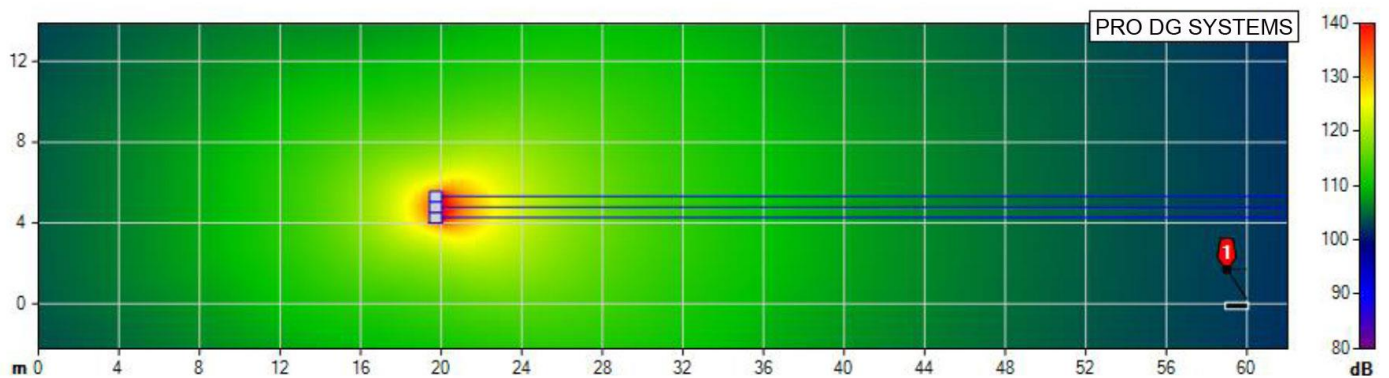

Reversed stack configuration

Placing three subwoofers in a stack format, with one of its units reversed.

Next, we will place the measurement microphone on the back, with the subwoofer in reversed position disconnected and the other two subwoofers on work, we will take a phase reference.

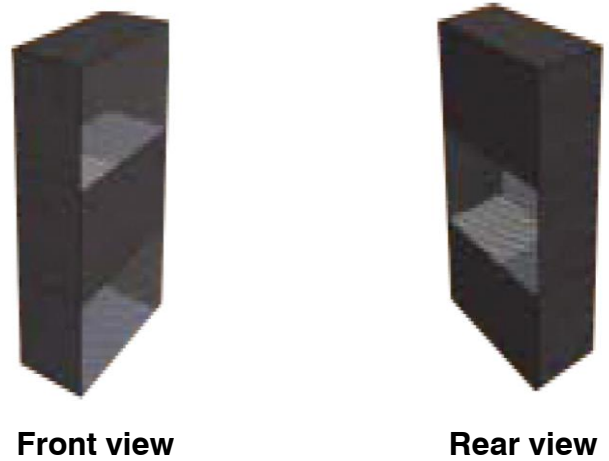

Then we connect the subwoofer in the reversed position and disconnect the other two subwoofers, we will take another reference and adjust it in phase by applying the corresponding delay (approximately 3ms), finally, we will apply a polarity change to the subwoofer in the reversed position.

What happen?

We will create interferences or constructive frequencies in the front, and destructive frequencies in the back.

That is, we will achieve a significant decrease in level on the stage and a slight decrease in pressure in the audience area.

Example of dispersion at 70 Hz:

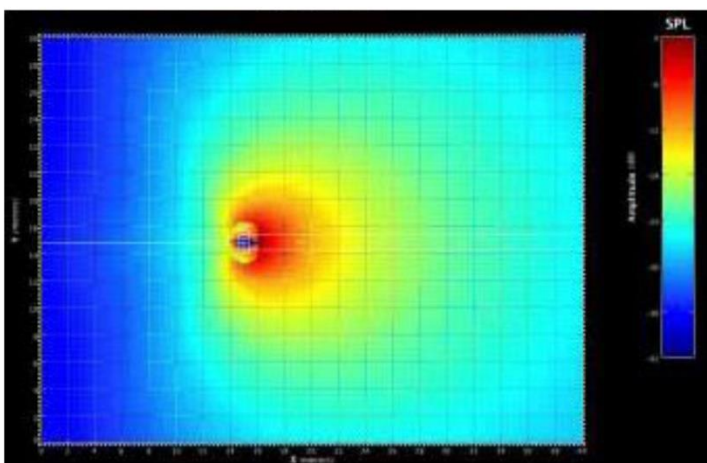
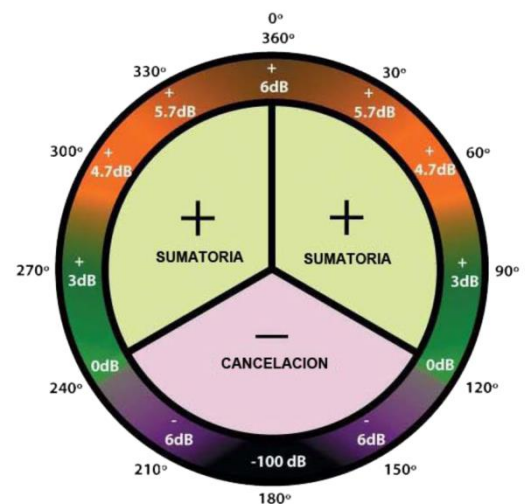

End-Fired configuration

Placing four in-line subwoofers, one after the other.

Although it is not a cardioid configuration, it is directional, producing attenuation in the rear and quite a bit in the front.

The physical separation distance between subwoofers will be determined by the key frequency. If, for example, we take 85 Hz as the key frequency, the separation distance between subwoofers will be 1m:

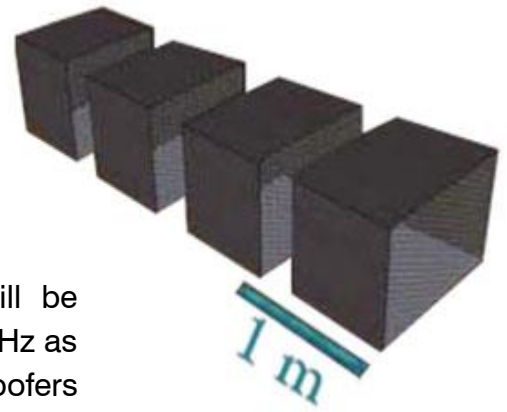

We must obtain the λ wavelength (lambda).

$\lambda = V/F = m$ V: speed of sound; 340 meters per second. F: frequency in Hz.

$340m \times sec / 85 Hz = 4m. / 4 (1/4 \text{ of the desired wavelength}) = 1 m$

Once the subwoofers are physically located, it will be necessary to apply delay to generate the necessary separation electronically, the objective is to make the four units behave as one.

This is what happens if we do not apply electronic delay:

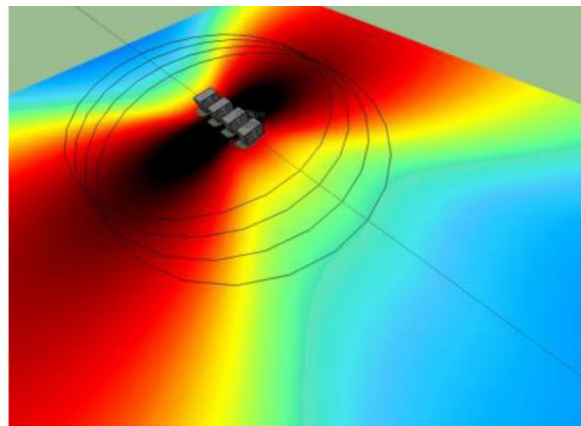

The delay that we must apply will be determined by the following formula:

$T = 1 / F$; $1 / 85 Hz = 0,01176 sec / 4 (1/4 \text{ of a cycle}) = 0,00294 sec \times 1000 = 2,94 ms$

Therefore;

- Subwoofer 1. Delay; 0 ms (It is understood that it is the closest unit to the stage)
- Subwoofer 2. Delay; 2,94 ms
- Subwoofer 3. Delay; 5,88 ms
- Subwoofer 4. Delay; 8,82 ms

Result of our configuration.
Completely matched in phase

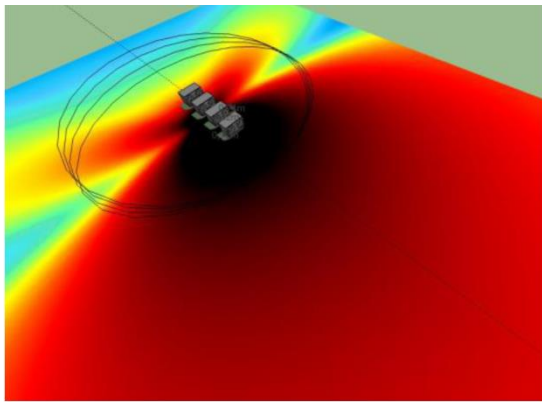
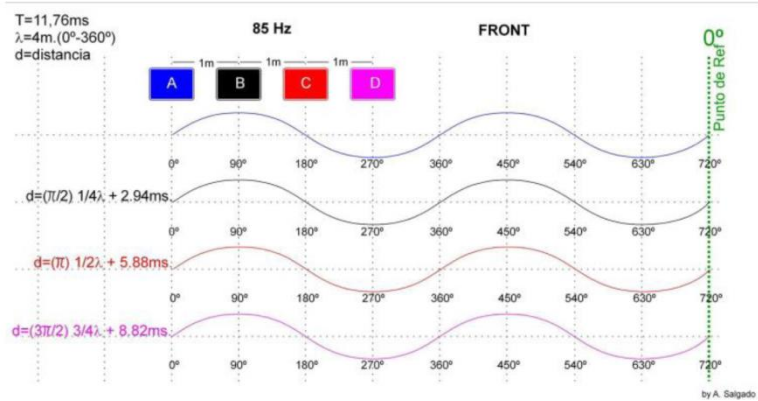

Lobe behavior after applying the electronic delay

As a result, in the rear part we obtain a large sum of constructive frequencies as all the sources are in 90° phase (summation), on the contrary in the rear part we have the four units in 180° push-phase (cancellation).

Therefore, we can consider that this configuration is not cardioid and is directional.

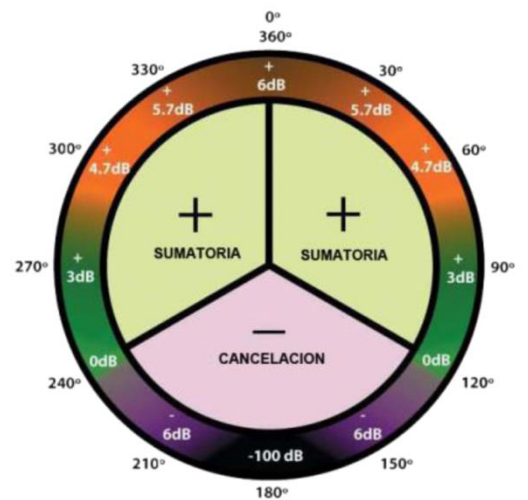

In-line cardioid configuration

Using two in-line subwoofers.

This configuration is formed with two sources spaced $\frac{1}{4}$ of the wavelength of the key frequency that we select. It is necessary to be clear about this concept; two parallel signals but with different paths, at the same point produce comb filters.

$\frac{1}{8}$ above the chosen key frequency, producing the first destructive frequency and the first cancellation.

Example: if we choose 40 Hz as the key frequency, we will have the first cancellation at 80 Hz (or what is the same in its first octave), which is not appropriate, because it destroys the frequency response of our configuration. And the same thing will happen with each odd multiple (80 x 3 = 240 Hz, 80 x 5 = 400 Hz, etc).

If we choose 85 Hz as the key frequency; We must obtain the λ wavelength (lambda).

$\lambda = V/F = m$ V: speed of sound; 340 meters per second. F: frequency in Hz.

$340m \times sec / 85 Hz = 4m. / 4 (1/4 \text{ of the desired wavelength}) = 1 m$

We can know that the physical distance between subwoofers will be 1 m

We have physically separated the subs 90° at 85 Hz, now we are going to electronically separate the rear sub another 90° , for this we convert 90° at 85 Hz in time.

$T = 1 / F$; $1 / 85 Hz = 0,01176 \text{ sec} / 4 (1/4 \text{ of a cycle}) = 0,00294 \text{ seg} \times 1000 = 2,94 \text{ ms}$.

In this way we will have the rear sub separated by 90° physically (with respect to the front) and another 90° electronically; $90^\circ + 90^\circ = 180^\circ$

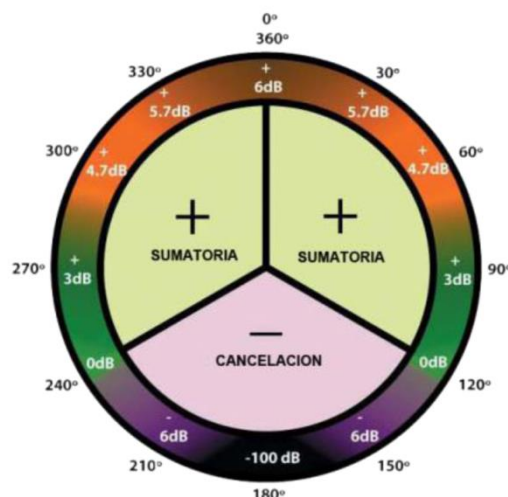
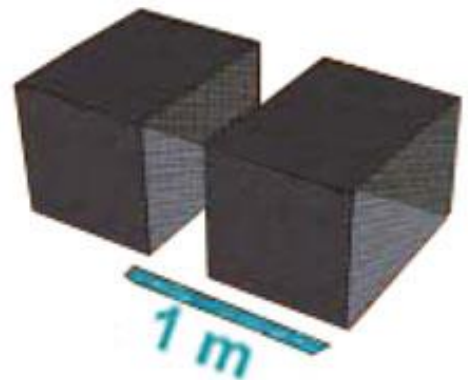

What happen?

Total cancellation of destructive frequencies. By simply reversing the polarity of the rear sub we once again have summation or constructive frequencies on the front.

Since the rear sub is physically distanced 90° from the front and another 90° electronically; $90^\circ - 90^\circ = 0$ constructive frequencies. But since it is inverted in polarity we obtain cancellation in the rear part (stage) and summation in the front part (audience area).

Example of dispersion at 70 Hz:

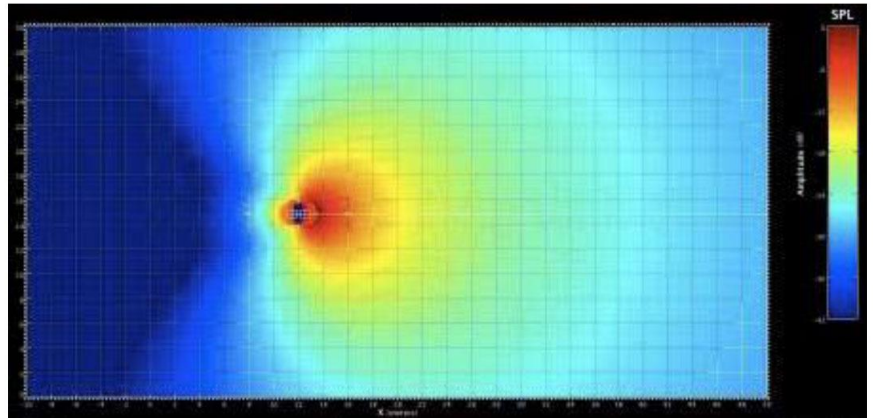

With this configuration we lose 1.5 dB compared to an in-block configuration of two subwoofers, but we will let our monitor colleagues work.

In-line horizontal configuration

Placing eight subwoofers besides to each other.

This configuration is based on the theory of Harry F. Olson published in his book "Acoustical Engineering" in which it is mentioned that; *placing two speakers at a distance equal to or less than half the wavelength of the upper cut-off frequency will create a highly directional forward lobe of energy.*

As we know, a standard L & R subwoofers configuration produces summation and cancellation zones dependent on the physical separation and, therefore, the wavelength of the frequency, appearing the typical "corridors".

To avoid these effects we are going to create a central line of subwoofers and reduce the distance between the elements, so that their separation is not greater than half their wavelength of the maximum frequency to be reproduced.;

λ Wavelength (lambda).

$\lambda = V/F = m$ V: speed of sound; 340 meters per second. F: frequency in Hz.

Choosing 100 Hz as example of maximum frequency, the result will be;

$340m \times sec / 100 Hz = 3,4m / 2 = 1,70 m$ (distance between subwoofers that we should not exceed).

As an example, we will make a configuration covering 14 m long and placing the subwoofers at a distance of 1.70 m from each other.

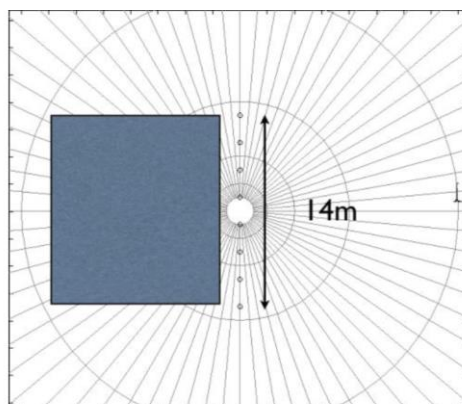

Once the subs are placed 1.70 m from each other, we will see the behavior of different frequencies to different degrees, taking the central axis as a reference. To observe the existing phase relationship in degrees we will use the formula;

$D \times F \times 360 / 340$ D; separation distance. F; Frequency.

360 a complete cycle and 340 the speed of sound.

We take as example a phase relationship in degrees for 100 Hz;

$$1,70 \times 100 \text{ Hz} \times 360 / 340 = 180^\circ$$

As we can see, the pattern narrows as we increase the frequency.

Conclusions: we should not separate the subwoofers more than 240° from the maximum frequency to be played, if we do so cancellations and the famous “passages” will appear.

This configuration is designed to work in closed spaces where we have side walls and we should not place the sub closest to the wall more than 120° from the maximum frequency to be reproduced.

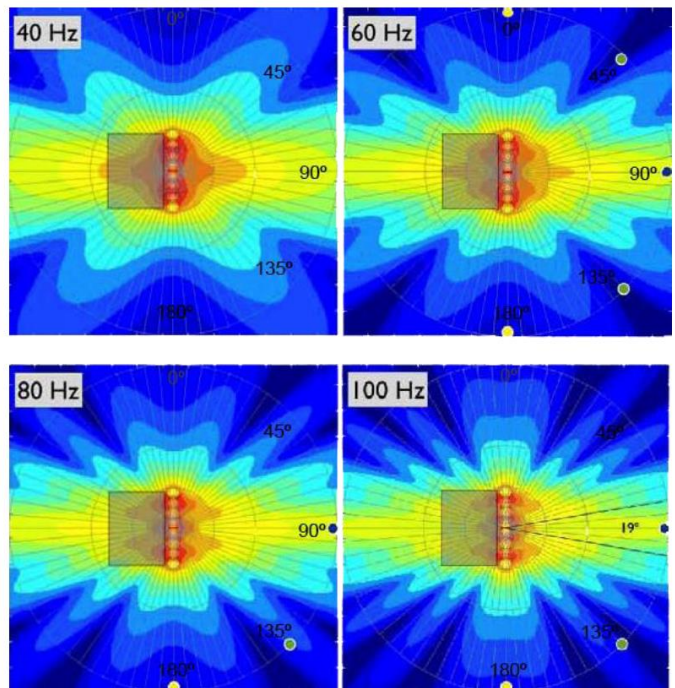

This configuration has a fairly narrow and long pattern, as a limit of coverage we will have the subwoofers placed in the extreme and in the stage part we will also have a lot of energy, which can be annoying for the monitor colleagues.

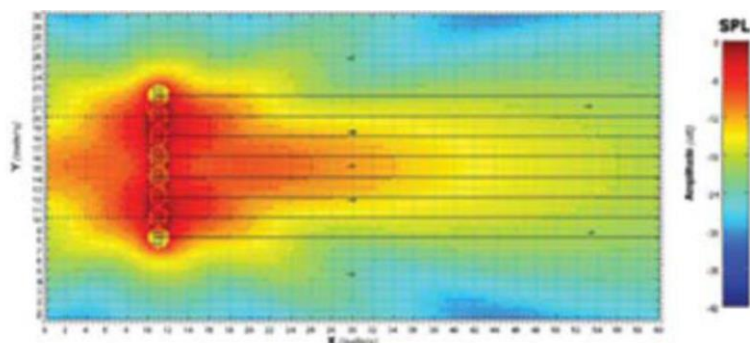

In-arc configuration

As with the configuration of eight subwoofers in-line horizontal, the difference is that we are going to sacrifice pressure in the central part, in exchange for gaining general coverage and reducing the pressure level on the stage.

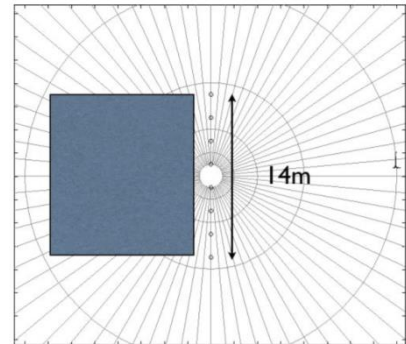

Taking the previous example as a starting point; we place the subwoofers at a distance of 1.70 m from each other and apply the following delays:

- Subs nº 4 and 5; 0 ms
- Subs nº 3 and 6; 1,50 ms
- Subs nº 2 and 7; 3 ms
- Subs nº 1 and 8; 4,50 ms

The lobe behavior will be as follows:

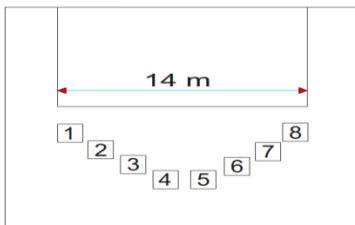

Virtual arch

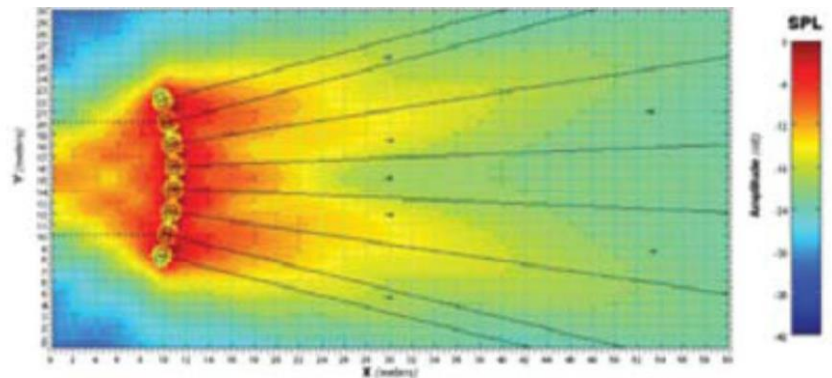

As we can see, we have gained general coverage with respect to the in-line horizontal configuration, but we have a slight reduction in level in the central area, this can be solved by placing a subwoofer above sub No. 4 and another above sub No. 5, thus recovering the level in the central zone.

If there is not enough processing available, we can make a physical arc by placing the subs in the following way:

- Subs nº 1 and 8; 0 m
- Subs nº 2 and 7; 0,5 m regarding sub 1 and 8
- Subs nº 3 and 6; 0,5 m regarding sub 2 and 7
- Subs nº 4 and 5; 0,5 m regarding sub 3 and 6

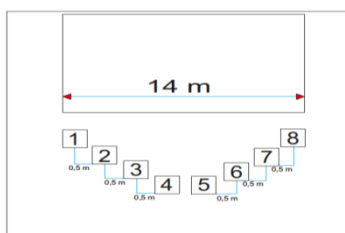

Physical arch

This configuration is increasingly used, it achieves a very homogeneous coverage, a good level in the audience area and a significant reduction in the stage area, its performance is very good in combination with Line Array systems.

Accessories

Complete system wiring ready to go.



GL-118-B



PRO DG SYSTEMS INTERNATIONAL

P.I. Santa Bárbara. C/ Aceituneros nº 5.

41580 Casariche (Sevilla), Spain

Tel: +34 954 011 095

Cel: +34 678 548 947

export@prodgsystems.com

info@prodgsystems.com

www.prodgsystems.com